



## Nano Backpack P5 (Nano-BP-P5)

### Deployment Guide

Document Number:	009-1778-00
Document Date:	March 2019
Document Supports:	da Vinci 8.7 and higher

# Contents

To access the link to the topics in this document, click the topic page.



1.	Introduction .....	4
2.	Deployment Steps.....	4
3.	Remote Basics .....	5
3.1.	Install Battery.....	5
3.2.	Button Descriptions - Remote .....	6
4.	Install Backpack .....	7
4.1.	Locate a Good Mounting Point.....	7
4.2.	Mount Breadboard to Mounting Bracket .....	8
4.3.	Mount Backpack to Breadboard .....	8
4.4.	Mount Backpack/Bracket Combo to TV .....	9
4.5.	Install Breadboard Support Post.....	10
5.	Connections.....	11
6.	Adding Backpack to a Local Network.....	12
6.1.	Add Backpack to a Wired LAN.....	12
6.2.	Add Backpack to Wi-Fi.....	13
7.	Update Firmware .....	15
7.1.	Download Firmware.....	15
7.2.	Locate IP Address .....	15
7.3.	Upload Firmware to Backpack.....	16
7.4.	FACTORY RESET Check box .....	16
8.	Blueprint Configuration.....	17
8.1.	Add Backpack to Blueprint .....	17
8.2.	Add to a Zone and Make Connections (IP Control Recommended).....	17
8.3.	Add to a Zone and Make Connections (IR Control) .....	18
9.	Blueprint - Upload Configuration .....	19
10.	On Screen Display Descriptions.....	20
	Appendix A: Additional Functionality .....	26
	Enable CEC.....	26
	ARC (Audio Return Channel).....	27
	Bluetooth Pairing .....	30
	Configure a Static IP Address .....	31
	DLNA .....	34
	On Screen Display Pop-Up Info Banner .....	35
	Appendix B: Network Requirements.....	36

## Important Safety Information - Read First



Before installing, configuring, or operating any equipment and other, Savant recommends that each dealer, integrator, installer, etc. access and read all the relevant technical documentation. Savant technical documentation can be located by visiting [Savant.com](http://Savant.com). Vendor documentation is supplied with the equipment.

Read and understand all safety instructions, cautions, and warnings in this document and the labels on the equipment.

## Safety Classifications In this Document

<b>NOTE:</b>	Provides special information for installing, configuring, and operating the equipment.
 <b>IMPORTANT!</b>	Provides special information that is critical to installing, configuring, and operating the equipment.
 <b>CAUTION!</b>	Provides special information for avoiding situations that may cause damage to equipment.
 <b>WARNING!</b>	Provides special information for avoiding situations that may cause physical danger to the installer, end user, etc.

## Electric Shock Prevention

-  **ELECTRIC SHOCK!** The source power poses an electric shock hazard that has the potential to cause serious injury to installers and end users.
-  **ELECTRICAL DISCONNECT:** The source power outlet and power supply input power sockets should be easily accessible to disconnect power in the event of an electrical hazard or malfunction.

## Weight Injury Prevention

-  **WEIGHT INJURY!** Installing some of the Savant equipment requires two installers to ensure safe handling during installation. Failure to use two installers may result in injury.

## Safety Statements

All safety instructions below should be read, understood, and applied under all relevant circumstances when working with this equipment.

1. Read these instructions.
2. Keep these instructions.
3. Heed all warnings.
4. Follow all instructions.
5. Do not use this apparatus near water.
6. Clean only with dry cloth.
7. Do not block any ventilation openings. Install in accordance with the manufacturer's instructions.
8. Do not install near any heat sources such as radiators, heat registers, stoves, or other apparatus (including amplifiers) that produce heat.
9. Do not defeat the safety purpose of any polarized or grounding-type plug. A polarized plug has two blades with one wider than the other. A grounding type plug has two blades and a third grounding prong. The wide blade or the third prong is provided for your safety. If any provided plug does not fit into your outlet, consult an electrician for replacement of the obsolete outlet.
10. Protect any power cord from being walked on or pinched; particularly at plugs, convenience receptacles, and the point where they exit from the apparatus.
11. Only use attachments/accessories specified by the manufacturer, following all relevant safety precautions for any such attachments/accessories.
12. Disconnect any outlet powered apparatus from its power source during lightning storms or when unused for long periods of time.
13. Refer all servicing to qualified service personnel. Servicing is required when the apparatus has been damaged in any way, such as a damaged power supply cord or plug, liquid being spilled or objects having fallen into the apparatus, the apparatus has been exposed to rain or moisture, apparatus having been dropped, or other failure to operate normally.
14. To completely disconnect this equipment from the AC mains, disconnect the power supply cord plug from the AC receptacle.
15. For applicable equipment, use the included power cord with the grounding prong intact to ensure proper grounding of the device.
16. For any hardwired or fixed in-wall apparatus, carefully follow all wiring diagrams and instructions. All electrical wiring and servicing should be performed by a properly licensed electrician.

# 1. Introduction

This document will guide the installer/integrator through the process of installing, configuring, and adding the Nano Backpack P5 surround sound processor / amplifier.

## Before You Begin

Read through this document in its entirety. Because the Backpack P5 can be installed into an existing Savant system or installed without adding to a Savant Control system, the devices are listed as such:

- 1. Savant Control System running da Vinci release version 8.7 or higher (needed only if being installed into a Savant System) .....
- 2. Artison Nano Backpack P5 (Nano-BP-P5) with remote.....
- 3. Peripheral devices (TV, speakers, subwoofer, HDMI Source such as an Apple TV or BD Player) .....
- 4. (OPTIONAL) CMP-XL mounting bracket.....
- 5. Savant Development Environment (SDE/MacBook®) (needed only if being installed into a Savant System) .....   
RacePoint Blueprint da Vinci 8.7 or higher
- 6. Ethernet network meeting Savant requirements .....   
See [Appendix B: Network Requirements](#)

# 2. Deployment Steps

Follow these steps to successfully deploy the Backpack P5 into a Savant Pro system. This page can be used as a checklist to record which steps have been completed. If not installing into a Savant Pro system, disregard any instructions referencing Blueprint or Racepoint Blueprint.

- 1. Review product specifications and connection details. See the Backpack QRG (009-1647) on the Savant Customer Community .....
- 2. Install battery into remote. See [Install Battery](#).....
- 3. Place Backpack into entertainment center, shelf, or rack ----or---- mount Backpack to rear of flat panel TV. See [Install Backpack](#).....
- 4. Wire the Backpack. See [Connections](#).....
- 5. Add Backpack to a local LAN or Wi-Fi network. See [Add Backpack to Local Network](#).....
- 6. Update Backpack firmware. See [Update Firmware](#) .....
- 7. Add Backpack to a Blueprint configuration. See [Blueprint Configuration](#) .....
- 8. Upload Blueprint Configuration. See [Upload Blueprint Configuration](#).....
- 9. Test.....

### 3. Remote Basics

The Backpack remotes are shipped without the battery installed. Section 3.1 below describes how to remove rear cover from remote and install the included battery. Section 3.2 describes the function of each button on the remote.

#### 3.1. Install Battery

The instructions below describe how to remove the battery cover from rear of remote and install the battery.

1. Flip remote over so the battery cover is accessible.
2. With a pointed object such as a paper clip, insert the end of clip into hole above the battery cover.
3. Push down on the tab inside the hole and pivot the paper clip so the cover is pushed downward and the cover is unseated.
4. Remove cover and set aside.
5. With thumb or small pointed object, pry the bottom side of battery and lift battery up and out of remote.
6. Remove included battery from the small plastic bag.
7. Insert the new battery (CR-2032) with the positive (+) side up.
8. Reinsert battery cover into slot. Press the cover inward and then up into position.

**⚠ IMPORTANT!** Dispose of the old battery into a proper recycling, hazardous waste, or designated battery drop off facility. Never discard the battery into the household trash.

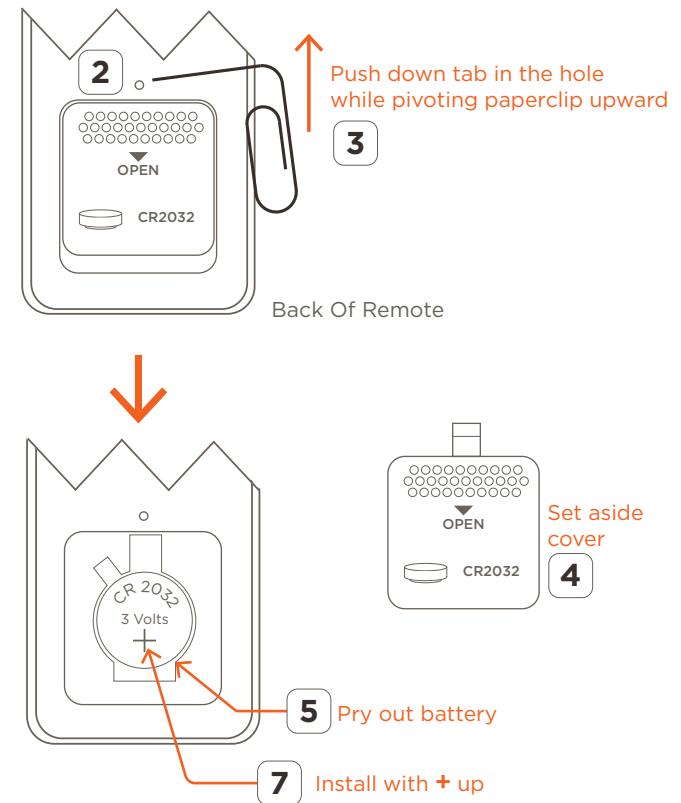

### 3.2. Button Descriptions - Remote

The remote contains numerous buttons on the front panel. How each button affects either the On Screen Display (OSD) or Backpack is described below.

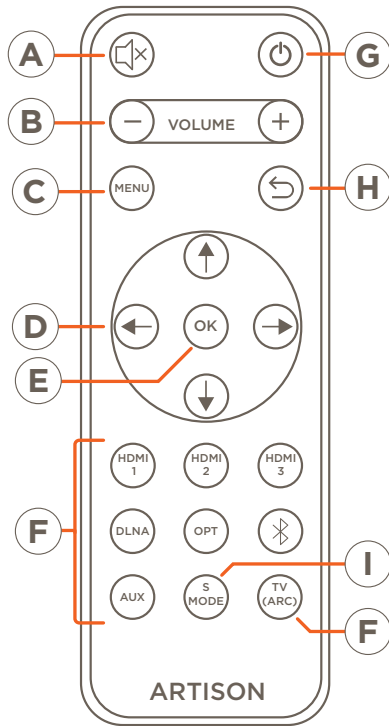

- 
- A** Mutes and unmutes the audio output of the Backpack.
- 
- B** Increases and decreases the volume output of the Backpack. As volume is increased or decreased, the volume level is displayed in one of the following:
- **Info Pop-Up Banner** - Banner that opens on the TV when volume +/- button is pressed.
  - **Front Panel LEDs** - On the front panel includes a series of blue LEDs that can track the volume.
- Note:** The LED's on the front panel can be set to ON, OFF, or AUTO DIM. Set this function to either ON or AUTO DIM to enable LEDs on front panel to illuminate. See the [OSD Preferences](#) section for more information.
- 
- C** Opens and closes the On Screen Display (OSD) menu.
- 
- D** The left, right, up, and down arrows have a few different functions depending on where in the OSD you are.
- When in the On Screen Display menu, pressing the left, right, up, and down arrows will help the user navigate through the various menus.
  - When renaming a label in the On Screen Display, the left/right arrow buttons move the cursor left or right and the up and down arrow buttons change the character
- 
- E** The OK button has a few different functions depending on where in the OSD you are.
- Press the OK button to either select or save a menu item in the On Screen Display.
  - Pressing the OK button with the OSD closed will open the OSD info pop-up banner.
- 
- F** Selects the input source. As each source is selected, the LED on the front panel will change to magenta and the port selected will appear for a few seconds in the OSD info pop-up banner.
- 
- G** Press to turn Backpack On. Press again to turn Backpack Off/Standby Mode.
- Standby Mode** - In Standby mode, the power switch on rear of Backpack is toggled On, but power is not applied to the Backpack. In this mode, the LED behind the dial on front panel illuminates red. In Standby mode, power consumption of the Backpack is reduced.
- 
- H** Returns the user to the previous screen in the On Screen Display (OSD).
- 
- I** Sets the surround mode for the input source selected. Each time the S MODE button is pressed, the mode is displayed in the Info Pop-Up Banner on the TV.  
(Available Modes: 2.1 Stereo, 5.1 Stereo, Dolby PLII Movie, Dolby PLII Music, DTS Neo: 6 Cinema, DTS Neo: 6 Music).
-

## 4. Install Backpack

The Backpack can be installed using one of the two techniques below:

- Can be installed into an entertainment center, shelf, or rack. When installing into entertainment center or similar, ensure the Backpack is placed in an area that is dry, well ventilated, and out of direct sunlight.
- Can be mounted to the rear of any flat panel TV using the optional CMP-XL mounting bracket. The next few sections describe how to mount to the rear of a flat panel TV using the VESA mounting points.
- Alternatively, TV mounts, as well as Speaker Brackets may be used to mount the Backpack.

### 4.1. Locate a Good Mounting Point

The CMP-XL mounting plate should be positioned so when the Backpack and CMP-XL brackets are mounted to the TV, there is minimal distance between the HDMI output port on the Backpack and the HDMI input port on the TV. Without making anything permanent, make a dry run and position the bracket and Backpack in the general location where they will be installed. The position should take into account the following:

- Ports on TV are not being covered.
- HDMI connection between the Backpack and the TV is kept short.
- Although not imperative, mount so front panel controls are accessible.
- Any TV wall mount brackets will need to be taken into account.
- Adding a Backpack to the rear of a flat panel TV could make the TV unstable and prone to tipping over. For TV's that are using the table mounts, it is advisable that the TV be secured to table or similar to prevent the TV from tipping over.

Below are a few examples of where the CMP-XL can be positioned when mounting to the rear of a TV. The diagrams show a left and bottom mount to two of the VESA mount points. In addition, the Support Post mount is shown on the breadboard opposite the mounting plate. The Support Post mounts to the rear of the TV using double sided tape. This support reinforces the breadboard and keeps it from flexing up and down on rear of TV.

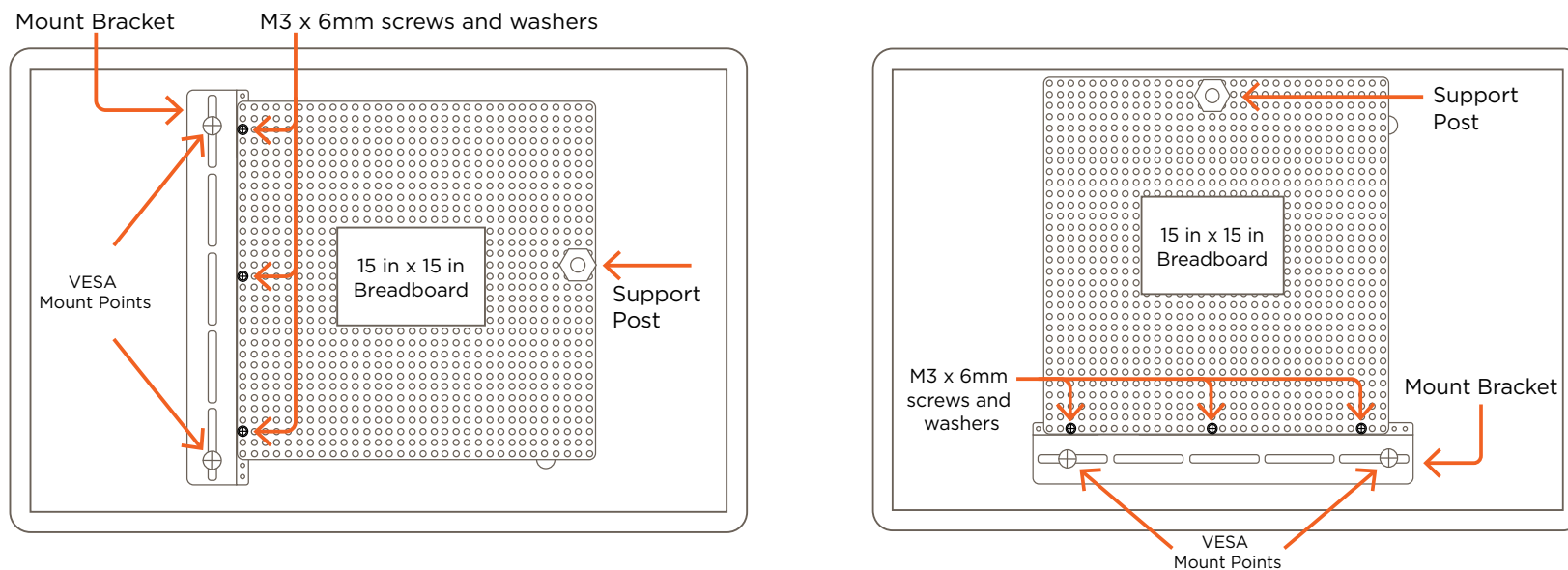

Follow procedure on the next few pages to mount the Backpack to the breadboard and then mount the assembly to the rear of the TV.

## 4.2. Mount Breadboard to Mounting Bracket

After getting a good idea of where on the back of the TV to mount, the 15 inch breadboard can be mounted to its mounting plate.

1. Position the 15 inch breadboard on top of the mounting bracket as shown in the image shown below.
2. Secure the breadboard to the mounting plate using three M3 x 6mm screws with integrated washer. Refer to the images on the previous page for approximate location of the screws.

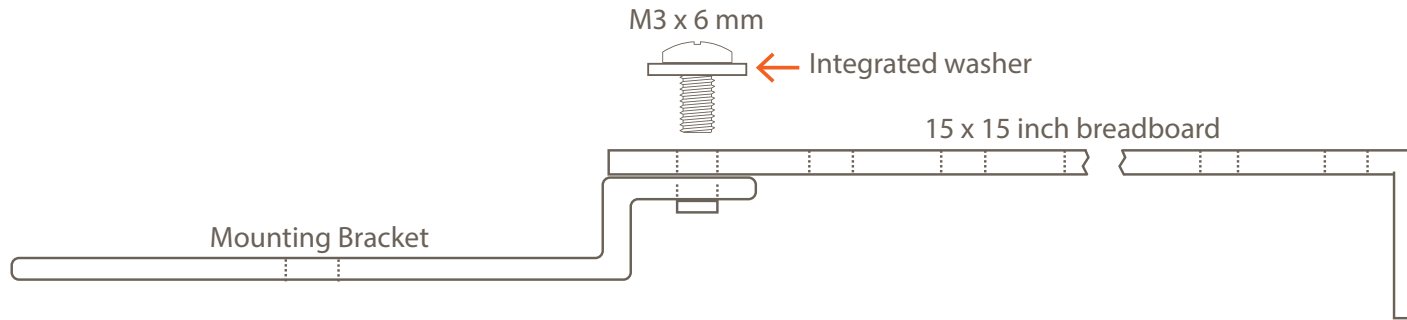

## 4.3. Mount Backpack to Breadboard

Mount the Backpack to the 15 inch breadboard.

1. Position the Backpack onto the 15 inch breadboard.
2. Install the Backpack mounting brackets on either side of Backpack and secure using the (4) M4 x 10 mm screws, washer, and star lock nuts. Refer to the image below.

**⚠ IMPORTANT!** Position the Backpack and related mounting brackets so when the combination is mounted to the rear of the TV, the brackets are located at the top and bottom of the Backpack. If not positioned correctly, the Backpack could slip down and out of the brackets, causing possible damage. Horizontal mounting will need alternative securing methods.

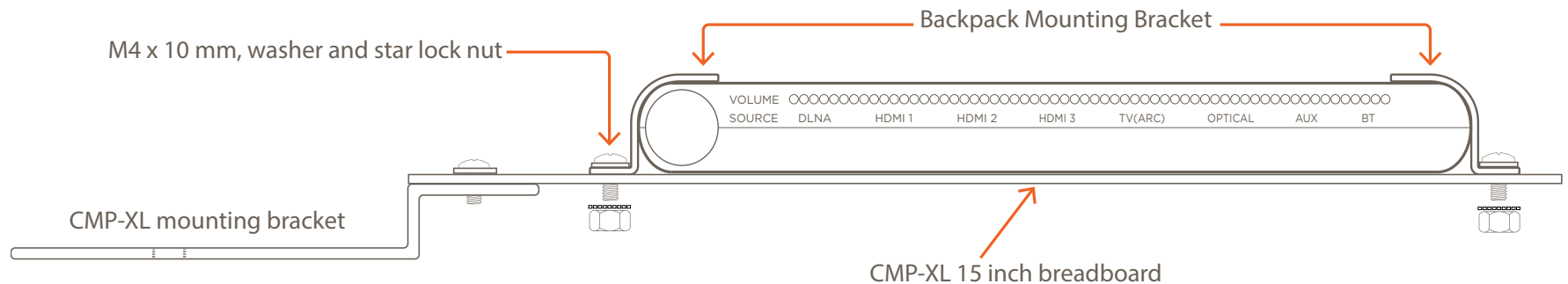



#### 4.4. Mount Backpack/Bracket Combo to TV

Mount the Backpack / CMP-XL combination to the rear of the flat panel TV. Insert screws through the slots in the CMP-XL mounting plate and into the VESA mounting points on rear of TV. Use one of the various sized screws supplied with the CMP-XL to mount to the TV. Do not tighten screws yet. The breadboard needs to be flexible for the next step.

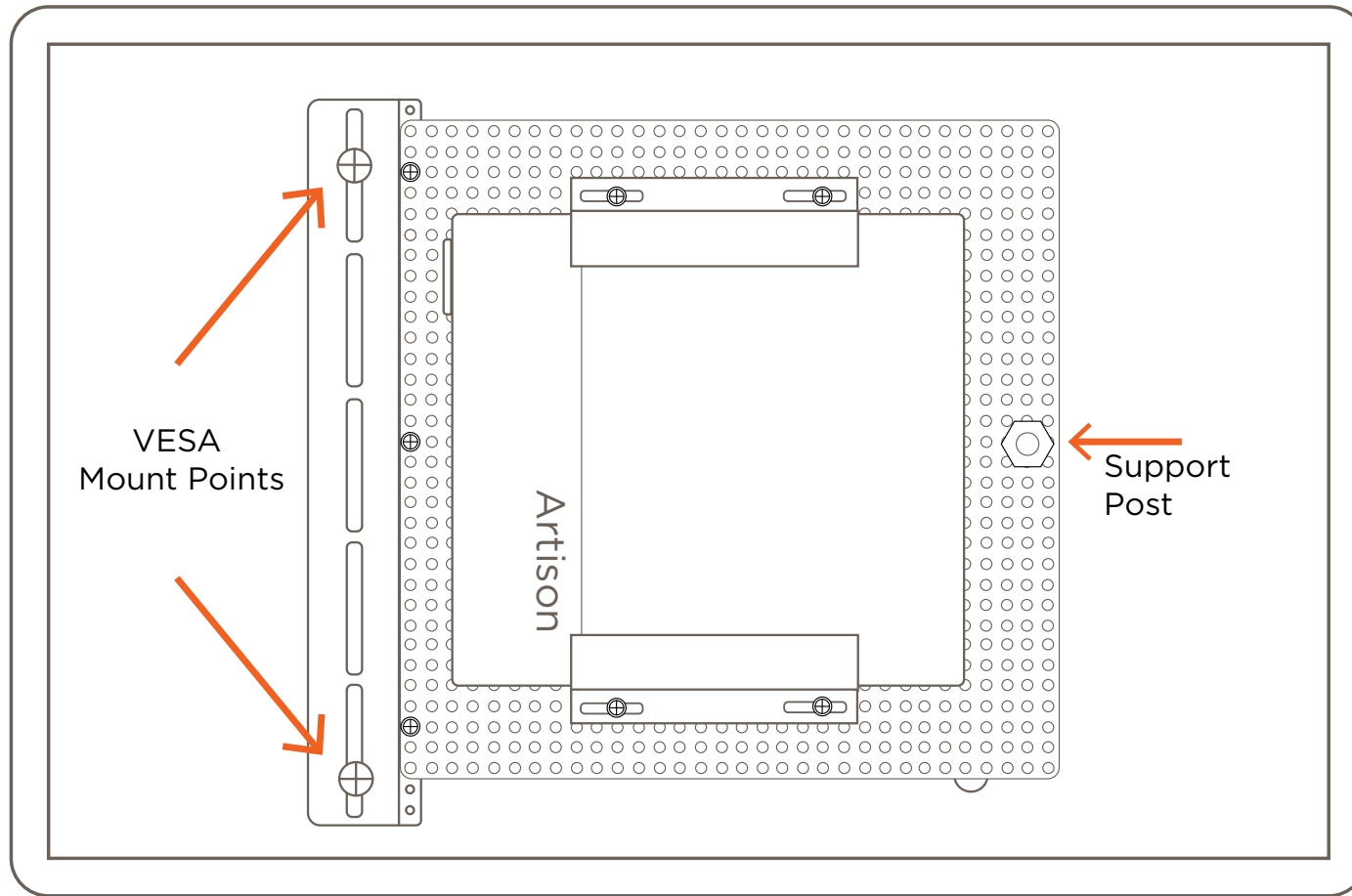

Rear View of Flat Panel TV

## 4.5. Install Breadboard Support Post

The support post secures the flexible side of the 15 x 15 inch breadboard (opposite the CMP-XL mount plate) to the TV. This post is mounted to the rear of TV using a peel off adhesive strip and once installed, keeps the breadboard from flexing. Follow instructions below to install the support post.

1. Screw one of the nuts on the support post completely onto the post. This will be the bottom nut. Remove the second nut.
2. Find a location under the edge of the breadboard that is flat and clear of any obstructions. Clean this section with an alcohol pad or similar.
3. Flex the breadboard up a bit and feed the post into one of the holes in the breadboard. Post should be close to the edge of the breadboard.
4. Remove the protective tape from the support post base and stick the base to the rear of the TV.
5. Unscrew the nut on the support post until the breadboard is parallel with the rear of the TV. The breadboard should now rest on top of the nut.
6. Screw the second nut onto the support post and sandwich the breadboard between the two nuts. Tighten nuts.
7. With a pair of pliers or similar, break off the extra threads from the support post at the break point (see image).
8. Tighten the screws mounted in the VESA mounting points. These screws were installed in section 4.4 above.

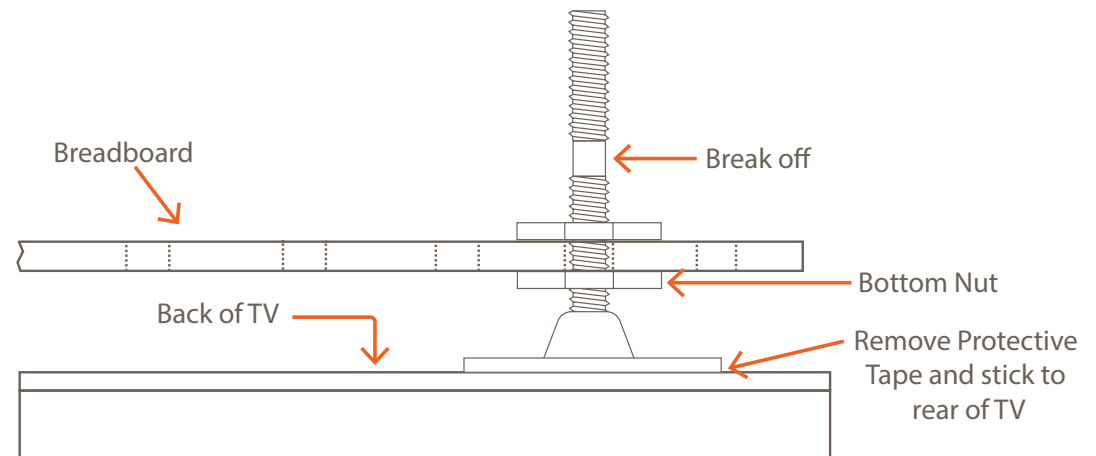

With Backpack secured to the rear of the TV, use the [Connections](#) section as a reference to make connections.

## 5. Connections

Use the wiring diagrams below to make the initial connections to the Backpack

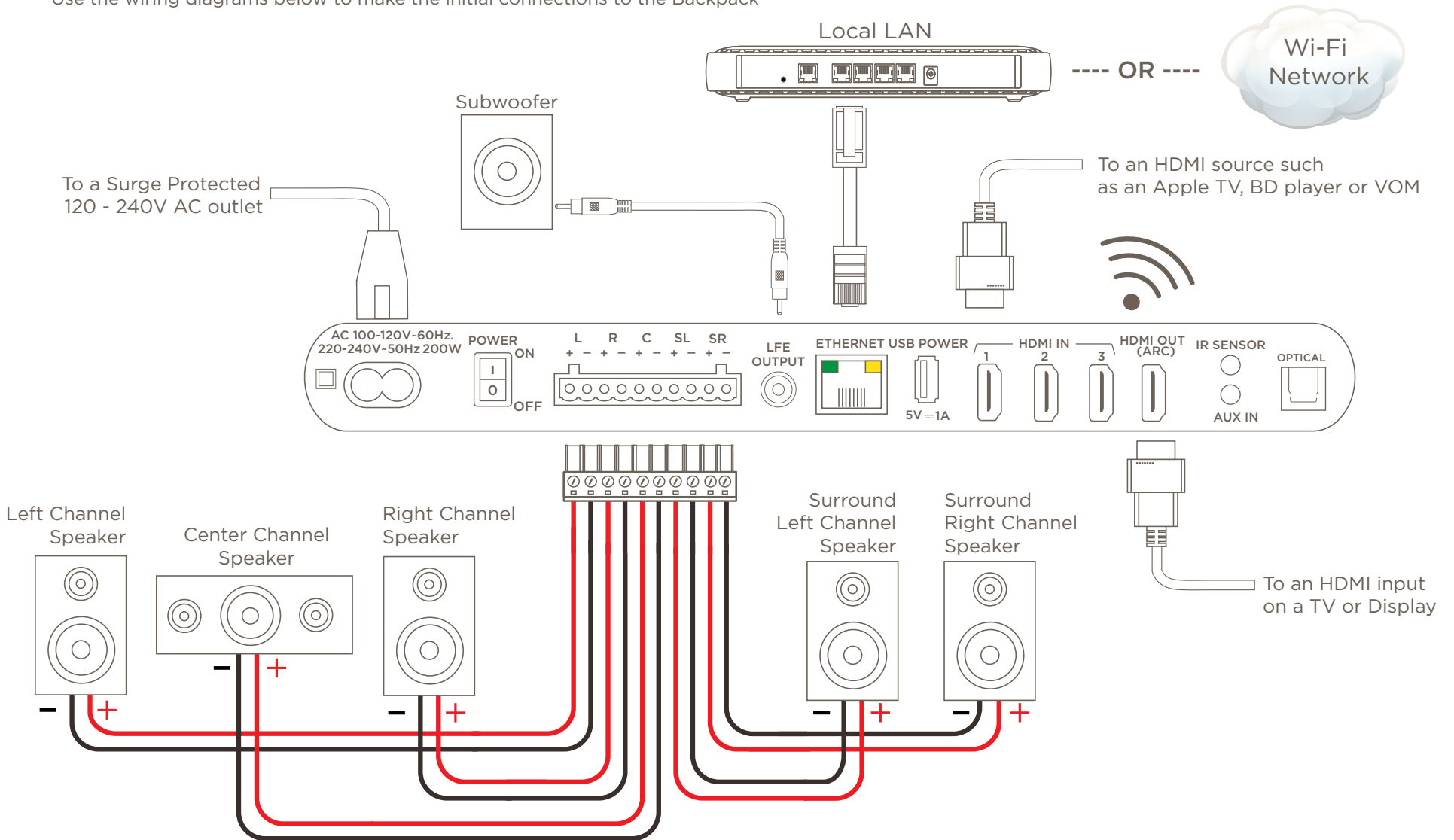

- The Backpack can communicate with the local network over either a wired or wi-fi network.
- #16 AWG is recommended for wire lengths up to 50 feet.
- #14 AWG is recommended if wire length is longer than 50 feet but less than 100 feet.
- #12 AWG is recommended if wire length is longer than 100 feet but less than 300 feet.
- The HDMI output cable that connects to the TV should be kept as short as possible to reduce any radio wave interference.
- Polarity (+/-) must be observed when making speaker connections.

## 6. Adding Backpack to a Local Network

Connecting to a local network is managed through a combination of the On Screen Display (OSD) and the Backpack embedded Web UI.

- How to add the Backpack to a wired LAN is described in [section 6.1](#).
- How to add Backpack to Wi-Fi section is described in [section 6.2](#).

Savant recommends using DHCP reservation. The methods described in the next two sections below assume DHCP is used. For information on setting a static IP Address, see the [Configure a Static IP Address](#) section at the end of this document

### 6.1. Add Backpack to a Wired LAN

#### Connect Cabling and Power the Backpack

1. Connect a Cat 5e/6/7 Ethernet cable between the local router and the Ethernet port on rear of Backpack.
2. Toggle On the ON/OFF power switch. The LED behind the multi-function dial on the front panel will illuminate red. Red indicates that the Backpack is in standby mode (has power but not switched on).
3. Set the input source on the TV to the port where the input HDMI cable is plugged into (not shown in image to the right).
4. Switch on the Backpack by doing one of the following:
  - Press and release the multi-function knob on front of the Backpack
  - OR**
  - Press and release the power button on the remote.

The LED behind the multi-function knob will illuminate blue.

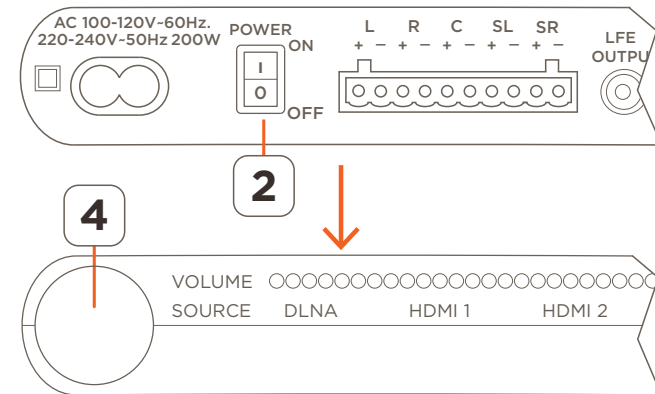

**TIP!** The blue LEDs will dim off after 5-10 seconds. If desired, the front panel LEDs can be configured to always be On, always be Off, or Auto Dim. This preference is set in the OSD (Main Menu > Preferences > LED).

#### Configure Backpack to Connect Through the Wired Port

5. Select the **MENU** button on the Backpack remote. Scroll to and select **Network Setup**. Select **OK**.
6. Verify the Network Select field is set to Wired. If not, set to Wired using the left/right arrow buttons on the remote.
7. Monitor the IP Address field and after about 30-60 seconds the Backpack will acquire an IP Address. Write the IP address on a separate notepad. It will be needed in the next section (Update Firmware).

**TIP!** When connected to the Ethernet port, the Backpack is assigned an IP address through DHCP. If an IP Address does not get assigned, remove and re-insert the Ethernet cable.

8. With the IP Address set and the Backpack communicating on the local network, the next step is to update the firmware. For instructions on how to update firmware, go to the [Update Firmware](#) section.

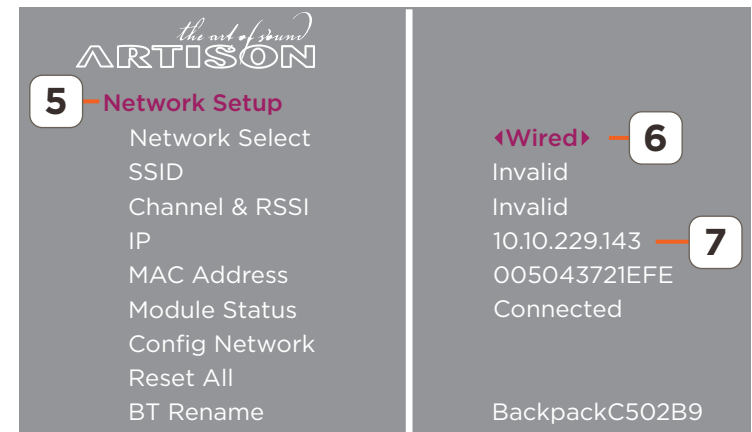

## 6.2. Add Backpack to Wi-Fi

### Power On the Backpack

If required, the power-on process is described in the [Connect Cabling and Power Backpack](#) section above.

### Configure Backpack to Connect to Wi-Fi

To connect to a Wi-Fi network, the Network Select field must be set to Wireless. Setting this field to wireless enables the wireless module embedded in the Backpack. Follow the instructions below to enable this function.

1. Select the MENU button on remote to open the Main Menu (not in image).
2. Using the UP/DOWN arrow buttons on the remote, highlight and select the **Network Setup** field.
3. In the page that opens, set the Network Select field to **Wireless**.
4. Monitor the Module Status field (this is the status of the Wi-Fi module). Initially, **Booting Up** is displayed.
5. After about 60 seconds, the Wi-Fi network module boots and the text changes to **Setup Network**. This indicates wireless module has completed its boot up process.
6. Scroll down to the Config Network field and select **OK**. This will put the Backpack into Broadcast/Adhoc mode. The OSD will show the following:

Now connect to SSID:  
Backpack\_C502B8 and log into  
IP Address 192.168.43.1  
in a web browser

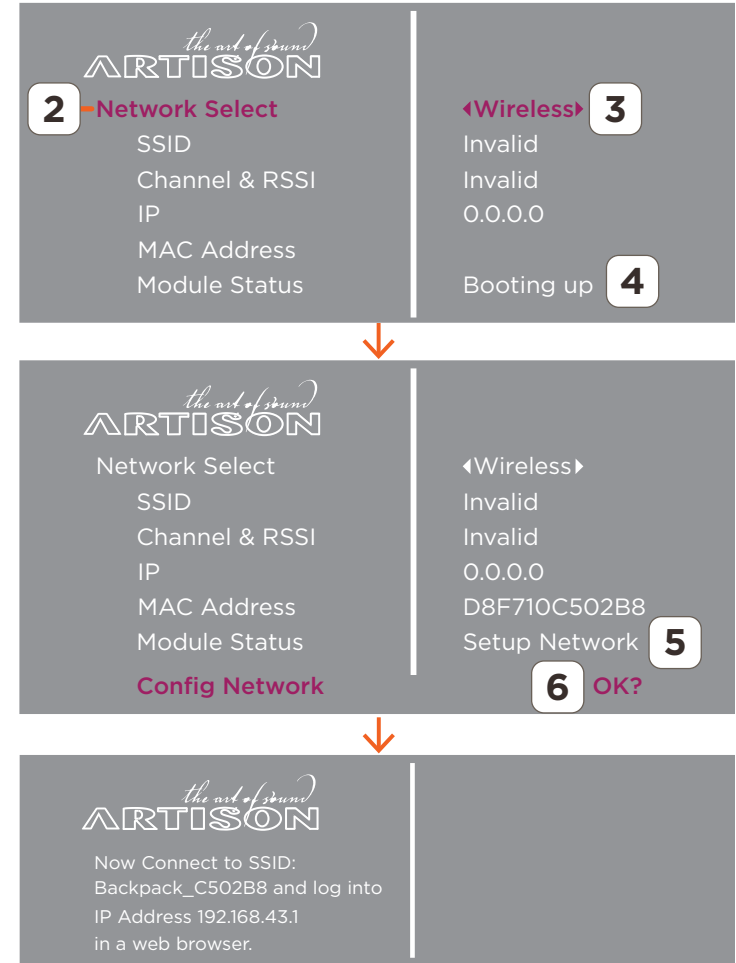

## Use Web UI to Connect Backpack to the Network.

7. On a laptop, PC, or MacBook, open the wireless network utility. With the Backpack within 10 feet of the PC or laptop, locate the Backpack from the list of SSID's and connect to it. Backpack will be listed as:

**Backpack\_C502B8** (C502B8 = last six digits listed in the MAC Address field)

8. Open a web browser and enter the IP Address: **192.168.43.1** into the Address bar. This is the IP Address of the Backpack wireless module when Backpack is set to Broadcast/Adhoc mode.



9. Under the SELECT NETWORK section of the Web UI that opens, select the local Wi-Fi network (SSID) from the drop-down menu of available networks.
10. Enter the PASSWORD to the network (SSID) selected.
11. Select **SAVE**. The Backpack will connect to the network and get assigned an IP Address.
12. To locate the new IP Address assigned to the Backpack, using the remote, open the OSD Main Menu. Scroll down and select **Network Setup**. The IP Address presented is the updated IP Address for the Backpack. Verify this IP Address coincides with the IP address range to your local Wi-Fi network.
13. To test, enter the new IP Address and verify the Backpack's DEVICE SETUP Web UI page opens (step not in image).

### ADDITIONAL INFO

- When the local Wi-Fi network is not listed in the drop-down menu, the network SSID and Password credentials can be entered manually. Select the **Configure Manually** field and enter the network **SSID**, **Security Type** (wpa, wpa2,...), and **Password** into the fields that open.
- To give the Backpack a Static IP Address, follow steps 9 and 10 above. Before saving, enable the **Static IP ON/OFF** field. In the additional fields that open, enter the proper data. Once entered, **SAVE** the credentials.

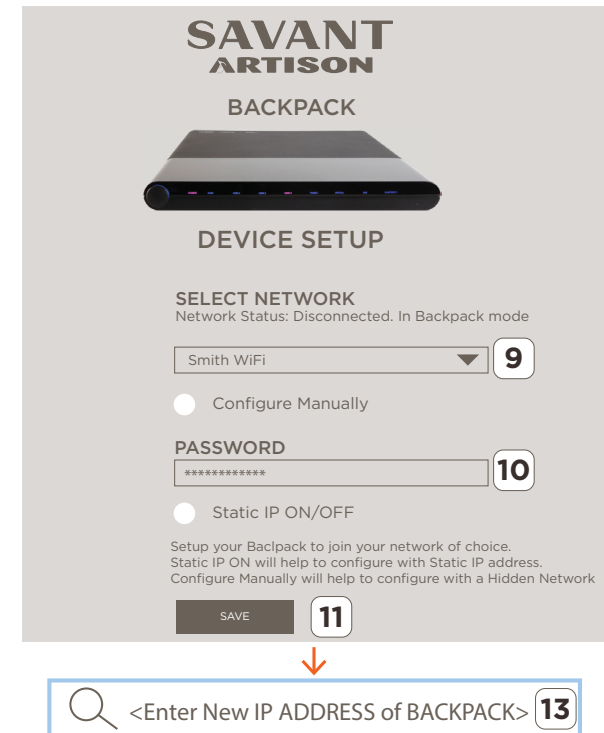

## 7. Update Firmware

The Backpack ships from the factory with a version of firmware that may not be the latest released version. Because of this, each Backpack should have its firmware updated. Follow the steps below to update the firmware version.

### 7.1. Download Firmware

Use one of the methods below to retrieve the firmware file.

#### Download File from Savant Store

1. Select the following link:

[Latest Backpack Firmware](#)

2. From the Backpack that opens, locate and download the firmware file (83\_image\_network(xx).zip)
3. Uncompress the downloaded file.

### 7.2. Locate IP Address

Locate the IP Address assigned to the Backpack.

1. Open the Backpack OSD.
2. Using the UP/DOWN arrow buttons on remote, scroll to Network Setup. Select **OK**.
3. Write down the IP Address shown in the **IP** field. This IP address will be used to access the embedded Web UI for the Backpack. Once IP address is obtained the Web UI can be accessed. Continue to next page for information on uploading firmware using the Web UI.

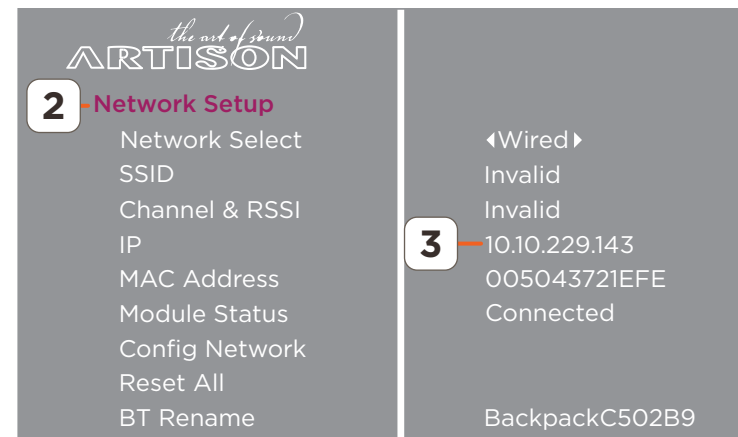

### 7.3. Upload Firmware to Backpack

The instructions below describe how to access the embedded WebUI and upload the firmware file to the Backpack.

1. Open a Web browser and enter the IP address of the Backpack into the address bar (See the [Locate IP Address](#) section above for information on getting the IP Address).
2. Select the **UPGRADE** button from the FIRMWARE UPGRADE section of the Web UI that opens.
3. Select the **CHOOSE FILE** button from the page that opens. Navigate to the file, and select **OPEN**. The file will automatically load into the CHOOSE FILE field.
4. Select the **UPDATE** button and follow the prompts and the firmware will begin loading. During the loading and installation process, a status screen will open that indicates the status of the update.



#### HELPFUL!

- During the update process, the LEDs on the front panel will begin to illuminate from left to right indicating that firmware is installing.
  - Do not unplug the AC power cord during the upload or install process.
  - When upload is complete (100%), the Backpack will reboot.
5. Verify through the on screen display that the correct firmware version was loaded (Main Menu > Preferences > Firmware Version).

#### Additional Information:

The naming of the firmware file breaks down as follows:

83\_IMAGE\_NETWORK\_LS98204\_1051051\_110\_100

- Wifi Version - 8204
- MCU Version - 1.05.1051
- DSP Version - 1.10
- OSD Version - 1.00

### 7.4. FACTORY RESET Check box

Resets the wired and wireless Ethernet modules. The IP Address assigned will be set back to the 0.0.0.0. When on a wired network, the Backpack is assigned a new IP Address. When on a wireless network, the [Add Backpack to Wi-Fi](#) process will need to be re-run.



**IMPORTANT!** The FACTORY RESET button in the Web UI has nothing to do with the firmware upgrade, although the positioning of the button suggests it does.



<Enter IP ADDRESS of BACKPACK>

1

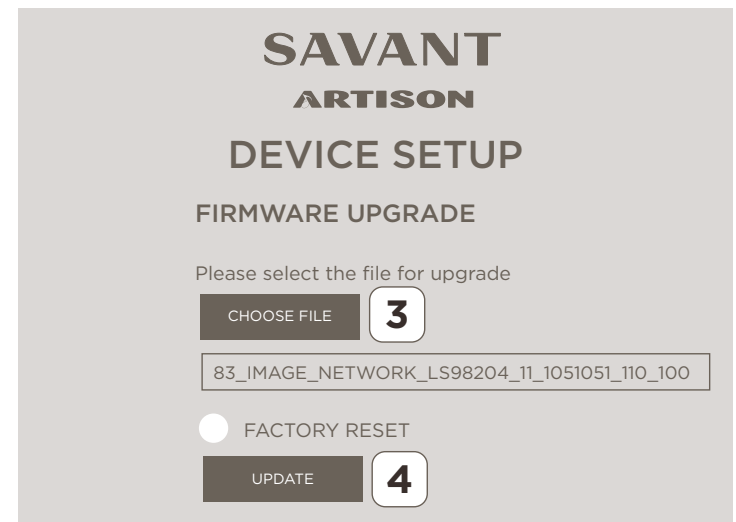



## 8. Blueprint Configuration

If the Backpack is being added to a Savant Pro system, it will need to be added and configured in Blueprint. Once complete, the configuration can be uploaded to the system Host. The steps below describe how to add the Backpack to a Blueprint configuration. Skip this section if the Backpack will not be added to a Pro System.

### 8.1. Add Backpack to Blueprint

1. Open the Savant Application Manager (SAM). 
2. Through SAM, open a Blueprint configuration.
3. Select **Show Library** from the Blueprint toolbar. This opens the Components library.
4. Enter **Backpack** into the Searchbar.
5. Drag and drop the Backpack P5 into either a User or Shared Equipment zone.
6. In the window that opens, enter a unique name that describes the Backpack being added (image not shown).
7. Select **Create** to add the Backpack.

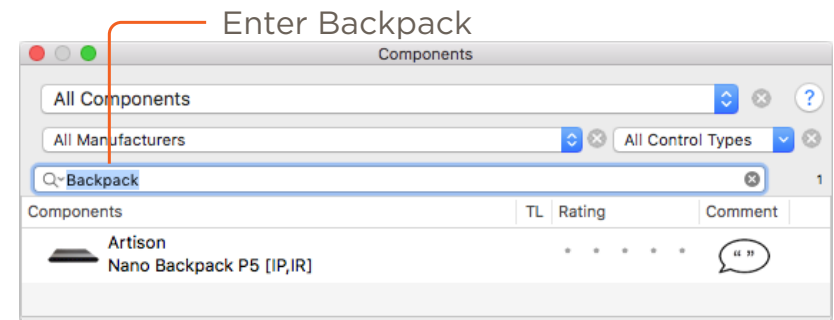

### 8.2. Add to a Zone and Make Connections (IP Control Recommended)

1. Drag the Backpack from the components list to the layout window.
2. Add the additional equipment that will be connected to the Backpack. In this procedure, a TV, Generic Surround speakers (non-powered), and Apple TV was added.
3. Connect one of the **HDMI In** ports to an HDMI output on an A/V device such as the Apple TV.
4. Connect the **HDMI Out** port to an **HDMI In** port on an HD TV.
5. Connect the Surround Speaker output on the Backpack to the Surround Speaker input on the Generic Surround Speakers.
6. Connect the **ETHERNET** port on the Backpack to a network switch or router. Enter the IP address of the Backpack in the IP connections need host address window that opens. Select OK.
7. When complete, the connections in Blueprint will look somewhat like the image to the right.

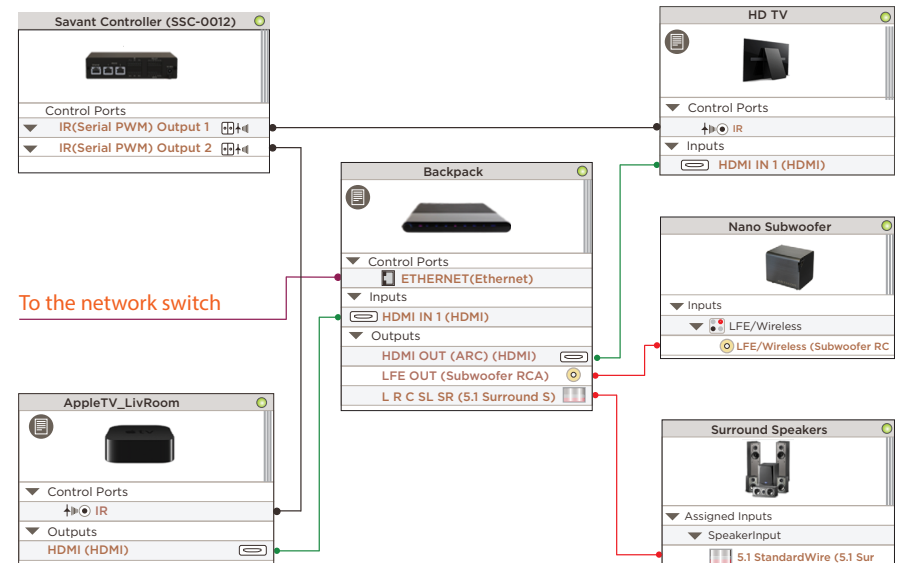

### 8.3. Add to a Zone and Make Connections (IR Control)

If IP Control is not available, the IR port on the Backpack can be used for control. The connections are all the same except the following:

- There is no Ethernet connection made between the Backpack and the local network switch. The Ethernet connection shown in the IP Control diagram above was removed.
- A control connection between a Savant controller and the IR Control port on the Backpack was added (SSC-0012 controller was used in this example).

See the image to the right.

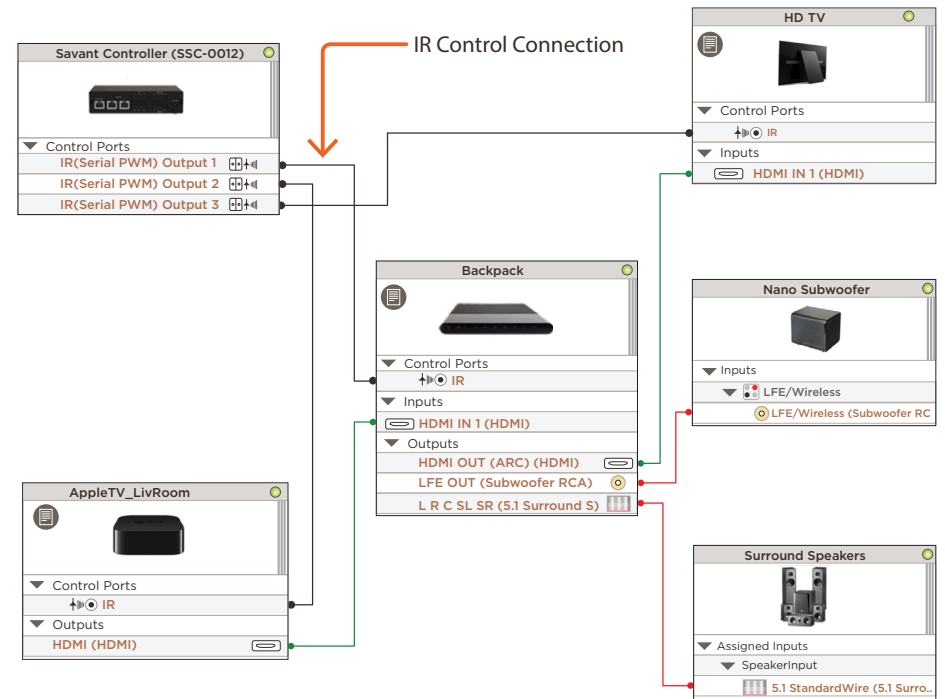

#### Connection for IR Control

The IR Control port on the Backpack is a 3.5 inch mini-jack located on the rear of the Backpack. The connection between the Backpack IR control port and the IR port on the SSC-0012 is shown in image to the right.

#### HELPFUL!

- Any commands that require feedback will not work when using IR for control.
- Since not all commands are supported, Savant recommends setting the system up to utilize IP Control as described in the [Add a Zone and Make Connections \(IP Control\)](#) section above.
- IR receiver is included in the package contents.

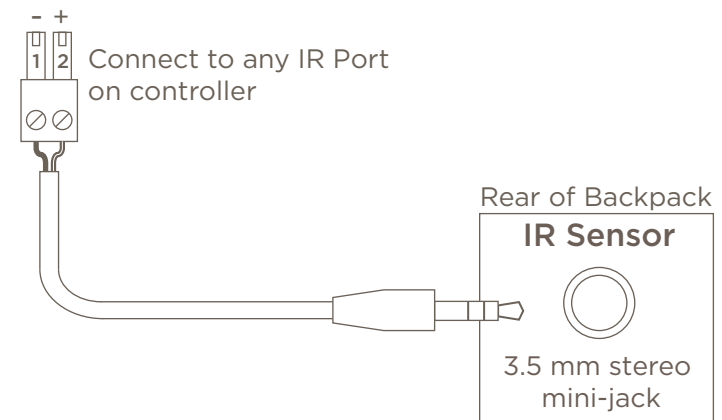

## 9. Blueprint - Upload Configuration

With the configuration complete, it can now be uploaded to the Savant Pro System Host. Follow steps below to upload.

1. Select the **Generate Services** icon from the Blueprint tool bar. The State Icon will change to either Blue or Green indicating the services are created.
2. Select **Update All UI Screens > Sync with Services** (only if necessary) to sync the user interfaces such as an iPad to the services created. The State Icon will switch to Green when complete.
3. To upload, select the **Upload to Master** icon from the Blueprint tool bar. See image below.

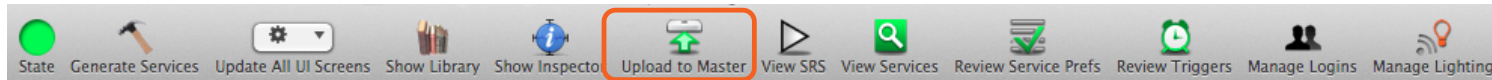

Select Upload to Master

4. In the configuration must be saved dialog box that opens, read the dialog and select **Save and Upload**.

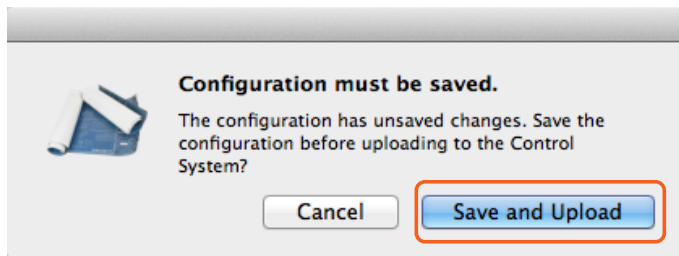

5. The System Monitor application will open as displayed below. Verify the path to the configuration file is correct. Select **Upload** when satisfied and the Configuration will upload to the Host.

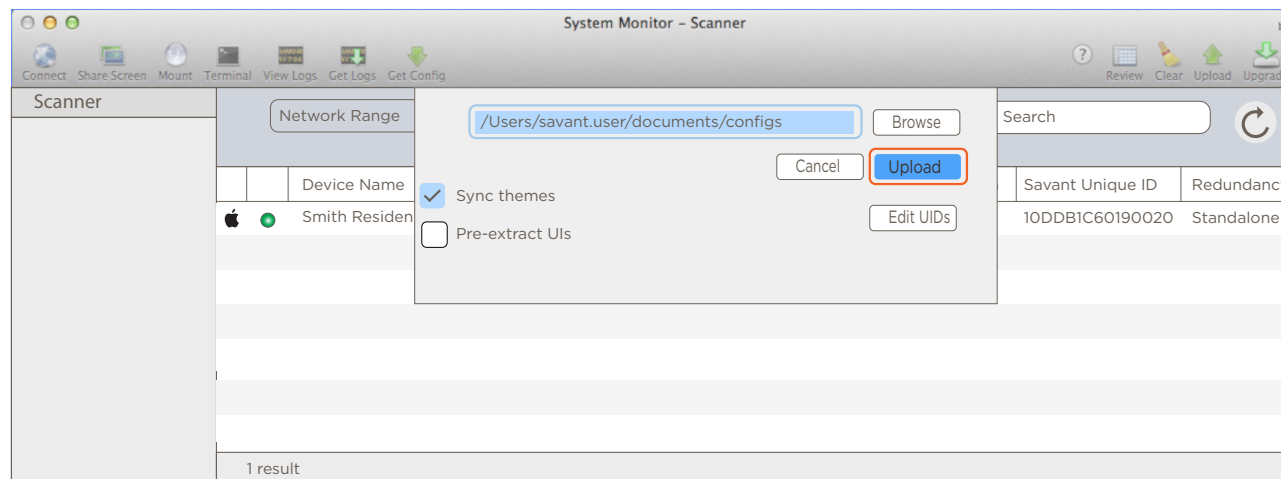

## 10. On Screen Display Descriptions

The On Screen Display menu has many fields. This section describes how to get to each field and gives a short description about the selection.



**Input Rename** - Can rename any of the input ports. The updated name will be displayed in the OSD Info Pop-Up Banner that opens at the bottom of the TV when certain buttons on the remote are pressed

### Example:

- With the **Input Rename** field highlighted, select the input to be modified.
- Use the UP/DOWN arrow buttons on remote to change the characters.
- Use the LEFT/RIGHT arrow buttons to move cursor one character to the left or right.
- Press the **OK** button to save the changes.



### Input Preferences:

**Source Enabled**  
(Default=Active)

Each input source (DLNA, HDMI, TV(ARC), etc) can be made active and inactive. With the input highlighted, use the LEFT/RIGHT arrow buttons on remote to toggle between active and inactive.

**Audio Delay**  
(Default = 0ms)

Audio Delay compensates for incorrect timing between the audio and video signal. With Audio Delay highlighted, use the LEFT/RIGHT arrow buttons on remote to increase or decrease the delay (Range 0-200 ms).

**Audio Setting**  
(Default = 2Stereo)

Sets the surround mode type for each input. Backpack supports:

(2Stereo, 5Stereo, Dolby PLII Movie, Dolby PLII Music, DTS NEO:6 Cinema, and DTS NEO:6 Music)

With Audio Settings highlighted, use the LEFT/RIGHT arrows to switch between modes.

**Audio Gain**  
(Default = 0 dB)

Sets the level of gain of the incoming signal. With Audio Gain highlighted, use the LEFT/RIGHT arrow buttons on remote to increase or decrease the gain (Range: -10 dB to +10 dB ).

**Max Volume**  
(Default = 100)

Sets the maximum level the volume can be increased to. With Max Volume highlighted, use the LEFT/RIGHT arrow buttons on remote to increase or decrease the level (Range: 0 - 100).

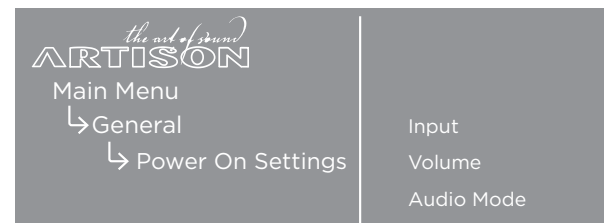

**Power On Settings** - Sets default values for the input, volume level and audio mode. Once set, the Backpack will power on to the settings chosen.



**⚠ IMPORTANT!** CEC must be disabled when using Backpack in a Savant Pro system. See the [Configure CEC](#) section in this document for more information.

CEC (Consumer Electronics Control), is a feature of the HDMI standard that is designed so control signals initiated from one device can communicate with other devices over HDMI. The following functions are available to Backpack from within the CEC Settings field:

- CEC**
  - Disabled** - When disabled, CEC on the Backpack is disabled. When set to disabled, the CEC signaling fields below will also be disabled.
  - Enabled** - When enabled CEC is enabled on the Backpack.
- Power On/Off** - User can enable or disable the Power On or Power Off command. When enabled, the Backpack can be switched On or Off by other supported CEC devices in the system. The CEC field above must also be enabled for the commands to be accepted.
- Volume** - User can enable or disable the Volume command. When enabled, the volume level of the Backpack can be changed by other supported CEC devices in the system. The CEC field above must also be enabled for the commands to be accepted.
- Source** - User can enable or disable the active input source command. When enabled, the input source selected on the Backpack can be changed by other supported CEC devices in the system. The CEC field above must also be enabled for the commands to be accepted.



**Auto Off** - Sets an inactivity timer. When the timer expires after inactivity, the Backpack will switch Off. Timer values are:

- Never
- 20 minutes
- 60 minutes

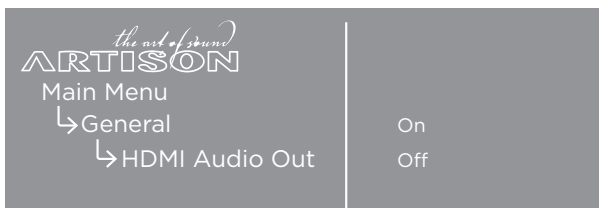

**HDMI Audio Out** - Set whether the audio signal from an A/V signal received on an HDMI input is transmitted to the HDMI output port. This function is helpful when the speakers on the TV can't be disabled.

- **On (Default)** - The audio of an A/V signal received on the input is transmitted out the HDMI output port to a display..
- **Off** - The audio of an A/V signal received on the input is NOT transmitted out the HDMI output port to a display..



**Audio Mux** - Sets whether the audio signal from a discreet audio input source (Optical, Analog Audio, Bluetooth, DLNA) is played to the output instead of playing the audio from the HDMI input signal.

- **Disable (Default)** - The audio received at the HDMI input is played to the output.
- **Enable** - The audio from one of the chosen audio source inputs is played along with the video from the HDMI input. To perform this function, select the HDMI input command followed by the discreet audio command

To enable this feature in Blueprint, the allow independent services check box in the user zone inspector window must be checked.



**HELPFUL!** When enabled, both input sources on the front panel of the Backpack will be lit. In addition, the OSD info pop-up banner that opens when pressing the OK button on the remote will display both active services.



**Network Standby** - The setting made determines if communications with the network will continue when Backpack goes into Standby Mode.

- **ON** - Network communication continues while Backpack is in Standby Mode.
- **OFF (Default)** - Network communication is suspended while Backpack is in Standby Mode. Power consumption is reduced while in Standby mode.



**Speaker Settings** - For each of the speakers in the system, the speaker size (large or small), the crossover frequency of the speaker, and slope need to be set. Use the following descriptions as a guide.

- **Speaker Size (Default = Large)** - The capabilities of the speaker determines whether Large or Small is set. When speaker can handle a full range of frequencies, set to Large. When speaker can only handle satellite frequencies, set to small. Refer to the frequency specifications of the speaker to determine the best setting.
- **Crossover (Default = 120Hz)** - The crossover point is where the frequencies higher than the crossover setting are sent to the speakers and the frequencies lower than the crossover point are sent to the subwoofer. Set the crossover frequency to the lower limit frequency that can be played through the speakers. Refer to the manual for the speakers installed for guidelines on where to set this.
- **Slope (Default = 12dB/Oct)** - As a general rule, set most speakers to 12 dB/octave. The frequency vs gain curve drop is more gradual than when set to 24 dB/octave. Some subwoofers can be switched between 12 and 24 db/octave. In this scenario it is best to match the setting.

**Speaker Level (Default = 0 dB)** - It is important to set the levels of each speaker be properly calibrated. The level for each speaker can be increased and decreased as required. The gain for each speaker can be adjusted from -10 dB to +10 dB. Before starting the level adjustments, the speakers must be setup in the position they would normally be set to, measuring all test signals at the normal listening level.

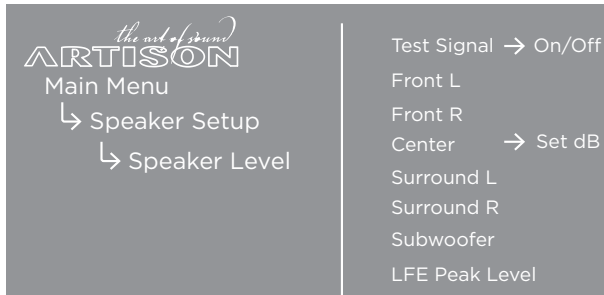

**Example 1: Make adjustments using the Test Signal**

1. Highlight the Test Signal field. Using the LEFT/RIGHT arrow buttons on remote, set to **ON**.
2. Select each speaker and the test signal will be played through that speaker. Using the same LEFT/RIGHT arrow buttons, increase or decrease the gain.

**Additional Information:**

- To make the adjustment process easier, the timeout for the speaker level screen is set to approximately five minutes.
- If the speaker level adjustments are already known, the adjustments can be made with no audio or test signal present.
- The speaker level function can also be used to troubleshoot possible speaker or wiring problems.

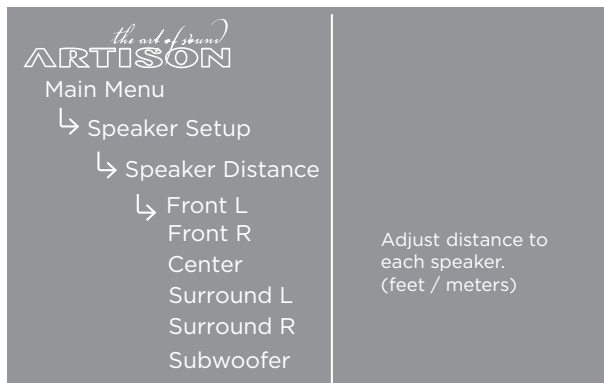

**Speaker Distance (Default = 0 ft)** - Speaker Distance or speaker delay is adjusted on each speaker so the audio reaches the normal listening position in the room at relatively the same time. Measure the distance from the common point in the room to each speaker and make the adjustments to each speaker in the Speaker Distance screen.

Distance Range = (0 - 33 ft in ¼ ft increments) or (0 - 10 meters in .10 meter increments)

The fields described below are all under Network Setup.

<b>Network Select</b>	<p>When the Backpack will be connecting to a wired network, set this field to <b>Wired</b>. Refer to the <a href="#">Add Backpack to a Wired LAN</a> section for information on how to connect to a Wired network.</p> <p>When the Backpack will be connecting to a Wi-Fi network, set this field to <b>Wireless</b>. Refer to the <a href="#">Add Backpack to Wi-Fi</a> section for information on how to connect to a Wi-Fi network.</p>
<b>SSID</b>	<p>Displays the SSID of the Wi-Fi network the Backpack is currently connected to. When Backpack is connected to a Wired network, Invalid is displayed.</p>
<b>Channel &amp; RSSI</b>	<p>Displays the channel and frequency band that the Backpack is connected to. The channel and RSSI are only presented for wireless networks. When connected to a Wired network, Invalid is displayed.</p>
<b>IP</b>	<p>The IP Address assigned to the Backpack is displayed.</p>
<b>MAC Address</b>	<p>Once connected to a network, the Mac Address of the wired or wireless module is displayed. <b>Note:</b> The MAC Address presented when connected to a wired network is different from the MAC Address displayed when connected to a Wi-Fi network.</p>
<b>Module Status</b>	<p>Displays the status of the Wi-Fi module. Connected, Not Connected, Booting Up, and Network Setup are a few statuses presented.</p>
<b>Config Network</b>	<p>With the Network Select field set to Wireless, highlight the Config Network field and select OK. This puts the wireless module in a state so it is ready to be added to a Wi-Fi network. Refer to the <a href="#">Add Backpack to Wi-Fi</a> section for more information.</p>
<b>Reset All</b>	<p>Resets the wired and wireless Ethernet module. The IP Address assigned will be set back to the 0.0.0.0. When on a wired network, the Backpack will automatically get assigned a new IP Address. When on a wireless network, the <a href="#">Add Backpack to Wi-Fi</a> process will need to be re-run.</p>
<b>BT Rename</b>	<p>The name that is broadcast and displayed in the Bluetooth devices utility of your Laptop, PC, or mobile Bluetooth settings page. The default name is Backpack followed by the last six characters of the Bluetooth wireless modules MAC Address. To change the name:</p> <ol style="list-style-type: none"> <li>1. Highlight the BT Rename field. Select <b>OK</b>.</li> <li>2. Use the UP/DOWN arrow buttons on the remote to change the character and use the LEFT/RIGHT arrows to move to the next character.</li> <li>3. Press <b>OK</b> on remote to save the changes</li> </ol>



**HELPFUL!** The last six digits which are the last six digits of the Mac Address of the wireless module cannot be modified.





<b>OSD Transparency</b> (Range 0-75%) (Default = 75%)	Sets the transparency of the Main Menu screen.  To modify, highlight the OSD Transparency field and using the LEFT/RIGHT arrow buttons on the remote, increase or decrease the transparency.
<b>OSD Color</b> (Default = BLUE)	Sets the color of the Main Menu screen (Blue or Gray).  To modify, highlight the OSD Color field and using the LEFT/RIGHT arrow buttons on the remote change to either Blue or Gray.
<b>INFO</b> (Default = ON)	Sets whether the OSD info pop-up banner that opens at the bottom of the TV can be displayed.  <b>ON</b> - The OSD info pop-up banner will open when the OK button, the volume UP/DOWN button, or any input source button on the remote is pressed. <b>OFF</b> - The OSD info pop-up banner will not open.  To modify, highlight the INFO field and using the LEFT/RIGHT arrow buttons on the remote, change to either ON or OFF.   <b>TIP!</b> Turning the dial on the Backpack front panel also opens the banner.
<b>LED</b> (Default = Auto DIM)	Sets how the LED's on the front panel are displayed.  <b>ON</b> - LED's are always ON. This includes the input source text. <b>OFF</b> - LED's are always OFF <b>AUTO DIM</b> - LED's will DIM and shut off after approximately 8-10 seconds  To modify, highlight the LED field and using the LEFT/RIGHT arrow buttons on the remote change to either ON, OFF, or AUTO DIM.
<b>UNITS</b> (Default = English)	Sets how the units such as the Speaker distances are set. Units are in either feet or meters.  To modify, highlight the UNITS field and using the LEFT/RIGHT arrow buttons on the remote change to either English or Metric.
<b>Firmware Version</b>	Displays the firmware versions currently loaded in the Backpack. There are four separate firmware versions and they are displayed like below: <ul style="list-style-type: none"> <li>• Wifi Version - 8204</li> <li>• MCU Version - 1.05.1048</li> <li>• DSP Version - 1.10</li> <li>• OSD Version - 1.00</li> </ul> To view, highlight the firmware version field and select OK on the remote.
<b>Factory Reset</b>	Reverts all settings listed on the Backpack back to their factory default values. This however excludes the network settings. The network settings fields includes a <b>reset all</b> function that resets the network modules.  To reset, highlight the Factory Reset field and select the <b>OK</b> on the remote. The Backpack will reboot and the factory settings will be restored.

## Appendix A: Additional Functionality

### Enable CEC

CEC (Consumer Electronics Control) is an optional feature of HDMI that allows a user control of numerous devices using one remote. For example the TV remote could be used to change the volume from a Blu ray player. Basically, once each CEC device is enabled, it sends out a ping and discovers other devices in the network that support it. Once complete, the individual CEC enabled devices can talk to each other. The diagram below shows this process.

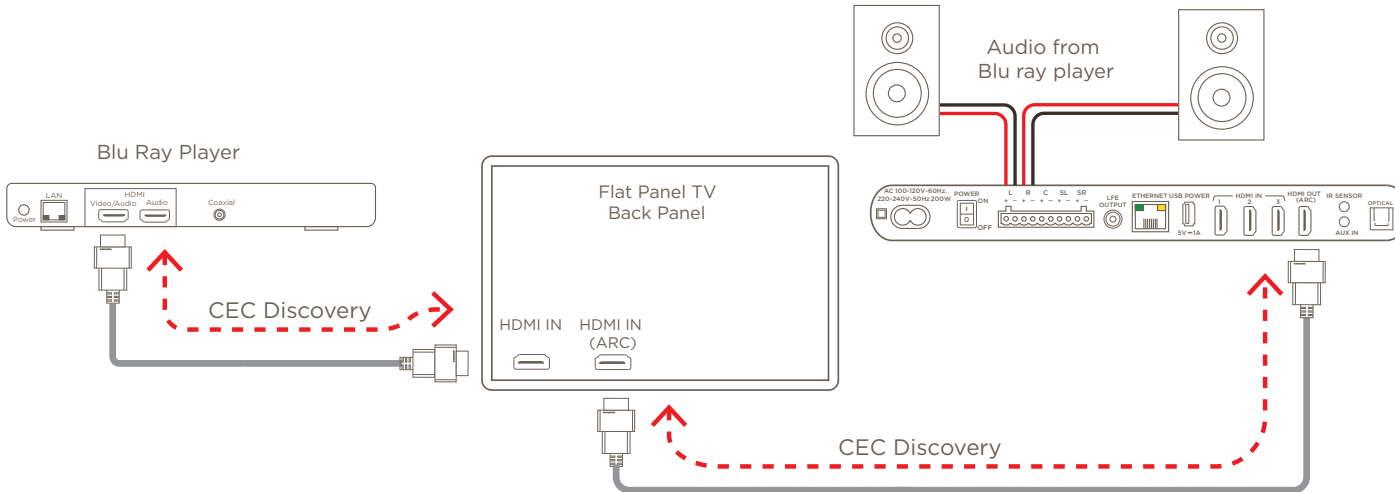

### Enable CEC

Follow the steps below to enable CEC on the Backpack:

1. Make HDMI connections between all the CEC supported devices in you system.
2. Press the **Menu** button on the remote to open the Backpack On Screen Display.
3. Select to open the **CEC Setting** field.
4. Enable the **CEC Enable** field. Use the LEFT/RIGHT arrow buttons on the remote to toggle between Enable and Disable.
5. Each of the remaining fields, Power On, Power Off, Volume control, and Source can be enabled or disabled individually. Decide which of the remaining functions should be enabled so they can function with CEC signaling.
6. CEC is now supported on the Backpack.

 **TIP!** If Device Discovery is not a function of the TV Menu, hot plugging the HDMI cable may be required to rediscover the CEC connection on the TV.



## ARC (Audio Return Channel)

HDMI ARC (Audio Return Channel) allows for two way communication between a TV and the Backpack over a single HDMI line. ARC reduces cable clutter, can move the HDMI connection made to the rear of the TV to the Backpack, and allows the audio from a device such as a Blu ray player to be played through the Backpack and out to a set of speakers. The diagram below is example of how ARC can play the audio from a Blu ray player to the output of the Backpack.

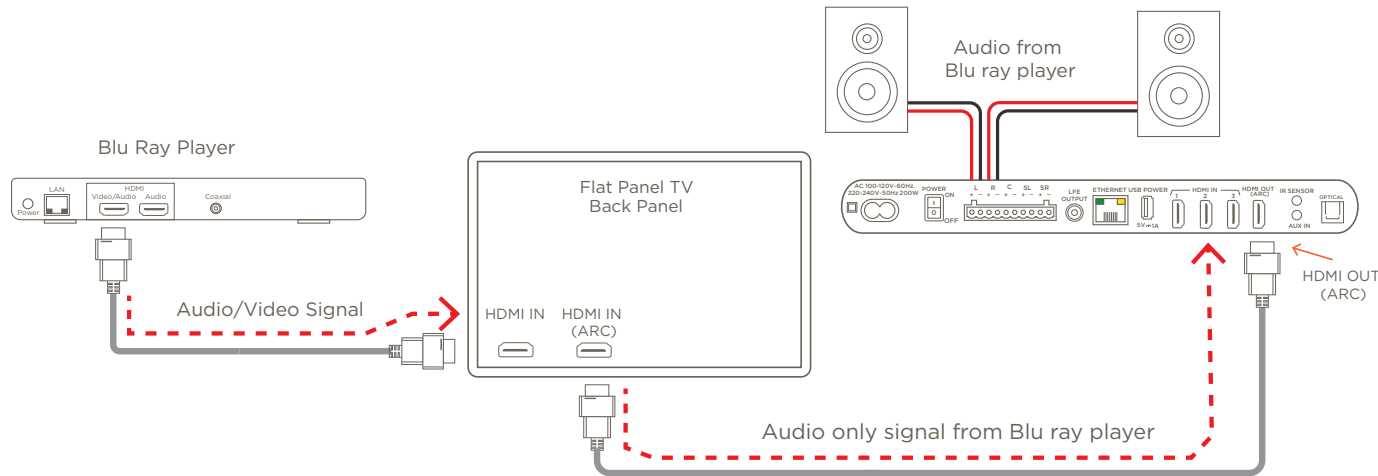

## Enable CEC for ARC

For ARC to function with the Backpack, the CEC function must be enabled. Enabling CEC allows the Backpack to be discovered by the TV and Blu ray player. PLEASE NOTE: Some manufacturers do not require a CEC process to be enabled in order to use ARC. Follow the steps below to configure CEC so that the ARC feature will function on the Backpack:

1. Make connections shown in diagram above and power on all devices.
2. Press **Menu** button to open the Backpack On Screen Display.
3. Select to open the CEC Setting field.
4. Set the CEC Enable field to **Enable**. Use the LEFT/RIGHT arrow buttons on the remote to toggle between Enable and Disable.
5. (OPTIONAL) Although not required, Savant recommends that the remaining CEC fields be enabled. Any fields left disabled will not function over CEC.
6. From the TV menu, select the source input connected to the Blu ray player, At this point, video and audio can play through the TV.
7. From the TV menu, navigate to and enable the CEC setting. Each brand of TV labels CEC differently. Refer to the manual for the TV to locate where the CEC setting resides and what other fields needs to be enabled/disabled for CEC to function. The Device Discovery process on the TV may need to be done.
8. Start a CEC device search for the TV. The TV will begin the discovery process and locate all the CEC supported devices and add them to its list.

With the process complete, the video from the blu ray player will play on the TV and the audio from the blu ray player will play to the speakers (through the Backpack).



## Download Firmware

See the [Update Firmware](#) section above on where and how to get the latest firmware

## Set Backpack to use the Wireless Module

Follow the instructions below to enable the wireless module.

1. Select the **MENU** button on remote to open the Main Menu (image not shown).
2. Using the UP/DOWN arrow buttons, scroll to and select Network Setup. This opens the Network Select menu.
3. Set the Network Select field to **Wireless** using the LEFT/RIGHT arrow buttons.
4. Monitor the Module Status field (this is the status of the Wi-Fi module). Initially, **Booting Up** is displayed.
5. After about 60 seconds, the Wi-Fi network module boots and the text changes to **Setup Network**.
6. Scroll down to the Config Network field and select **OK**. This puts the Backpack into broadcast mode. The OSD will show the following:

Now connect to SSID:  
Backpack\_C502B8 and log into  
IP Address 192.168.43.1  
in a web browser

7. On a PC, Laptop or MacBook, open the wireless network utility.
8. Locate and select the Backpack from the list of wireless devices. The Backpack will then connect to the PC, Laptop, or MacBook. Note that the connection process can take up to 20 seconds



**HELPFUL!** The Backpack will display in wireless utility like below:

**Backpack\_<Last Six Digits of Mac Address to the Wireless Module>.**

Refer to the image to the right.

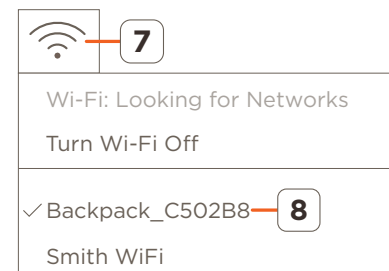
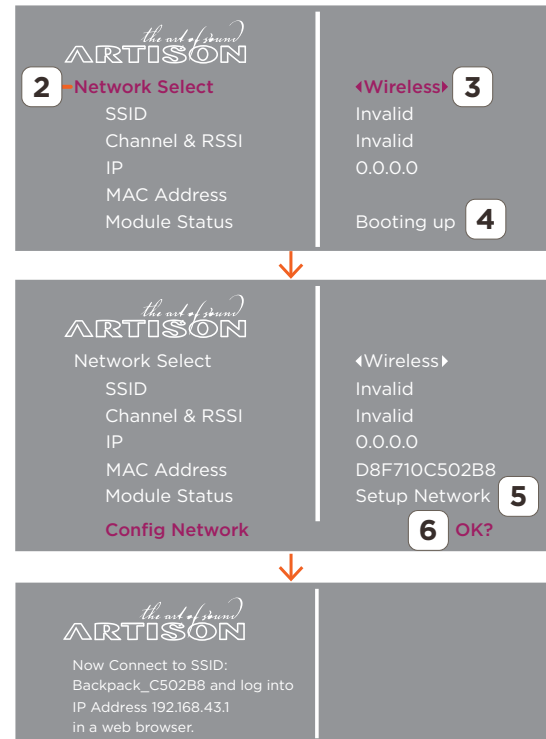

## Connect to Web UI and Upload Firmware

Connect to the Web UI using the IP Address of the Backpack while in broadcast (Adhoc) mode.

9. Open a Web browser and enter the **192.168.43.1** IP address. This is the IP Address given to the Backpack from the previous section.
10. Select the **UPGRADE** button in the FIRMWARE UPGRADE section.
11. Select the **CHOOSE FILE** button from the page that opens. Navigate to the file, and select **OPEN**. The file will automatically load into the field below the CHOOSE FILE button.
12. Select the **UPDATE** button. The firmware will begin uploading to the Backpack. During the upload and install process, answer the prompts.



**HELPFUL!** During the install process, the LEDs on the front panel will illuminate from left to right indicating that firmware is installing. DO NOT disconnect power during the upgrade process.

13. When upload is complete (100%), the Backpack will reboot.
14. Verify through the on-screen display that the correct firmware version was loaded. (Main menu > Preferences > Firmware Version).

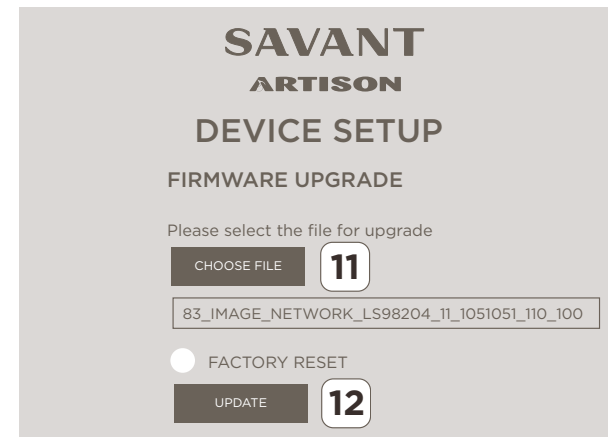
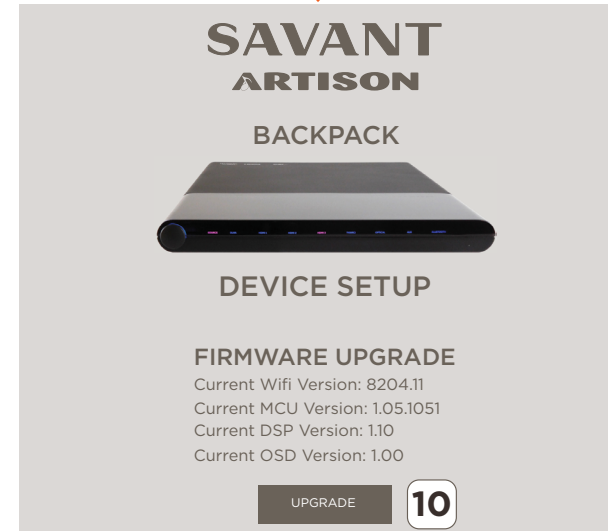

## Bluetooth Pairing

Below are instructions on how to pair the Backpack with a device such as a mobile phone or similar using Bluetooth.

1. Power on the Backpack. This is described above in the [Add Backpack to a Wired LAN](#) section above.
2. On the OSD, navigate to and select Network Setup.
3. Scroll down the Network Setup page to the BT Rename field. Make a note of the name in this field. This is the name that will be broadcast on your bluetooth supported device (phone, tablet, etc.).



**TIP!** To change the name that is broadcast, do the following:

- Highlight the BT Rename field. Select **OK**.
  - Using the LEFT/RIGHT/UP/DOWN arrows on the remote, update the name. The last six digits which are the last six digits of the Mac Address of the wireless module cannot be changed.
  - Select **OK** when complete.
4. Open the Bluetooth menu on your bluetooth supported device.
  5. Locate and select the Backpack from the list. At this point, Backpack will connect to your device. Note that the connection process can sometimes take up to 20 seconds to negotiate.



Name Broadcast  
over Bluetooth

Bluetooth  
Supported  
Device →

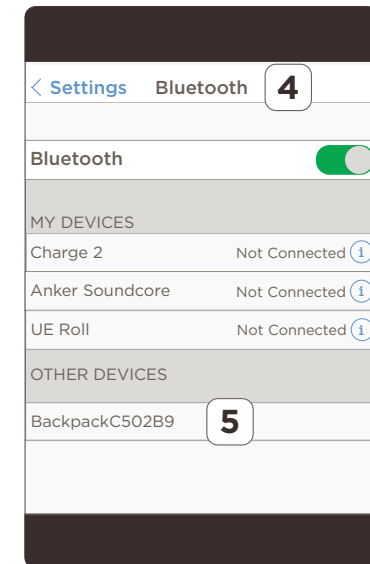

## Configure a Static IP Address

The Backpack supports setting a static IP Address. There are a couple methods that can be used to set static IP. They are as follows:

- With the Backpack already on the network and assigned an IP Address, the We UI can be used to set the static IP.
- When Backpack is not already connected to the local network or the local network is hidden, it can be put into Adhoc mode and assigned a static IP.

Both methods are described below:

### Assign Static IP (Backpack already on the Network)

1. If an IP Address is not already assigned, configure a temporary IP Address onto the Backpack through either a wired or wireless connection. This is described in the [Add Backpack to a Wired LAN](#) or in the [Add Backpack to Wi-Fi](#) section. If an IP address is already assigned through DHCP, the IP address of the Backpack is available in the OSD (Main Menu > Network Setup).
2. Open a Browser and enter the IP Address assigned to the Backpack. This opens the Backpack Web UI.
3. Scroll down and enable Static IP ON/OFF.
4. Enter the required information in the fields that open.
5. Select the **SAVE** button. The information will now be saved into the Backpack.
6. After about 10 seconds, open a new browser and enter the new static IP Address. The Backpack Web UI will open and the new static IP information will be populated under the Static IP Address section.

2 < Enter IP ADDRESS of BACKPACK >

SAVANT  
ARTISON  
BACKPACK

DEVICE SETUP

3  Static IP ON/OFF

To configure Static IP, please fill in all of the fields.

IP ADDRESS  
0.0.0.0

NET MASK  
0.0.0.0

4 GATEWAY  
0.0.0.0

PRIMARY DNS  
0.0.0.0

SECONDARY DNS  
0.0.0.0

5 SAVE

Setup your Backpack to join your network of choice. Static IP ON will help to configure with a Static IP address. Configure Manually will help to configure with Hidden Network

## Assign Static IP (Backpack not on Network)

Follow steps below to assign a static IP to the Backpack using Adhoc mode method. This method saves a few steps if the Backpack has not already been assigned an IP Address or the local network is hidden.

1. Select the **MENU** button on remote to open the Main Menu (image not shown).
2. Using the UP/DOWN arrow buttons, scroll to and select Network Setup. This opens the Network Select menu.
3. Set the Network Select field to **Wireless** using the LEFT/RIGHT arrow buttons.
4. Monitor the Module Status field (this is the status of the Wi-Fi module). Initially, **Booting Up** is displayed.
5. After about 60 seconds, the Wi-Fi network module boots and the text changes to **Setup Network**.
6. Scroll down to the Config Network field and select **OK**. This puts the Backpack into broadcast mode. The OSD will show the following:

Now connect to SSID:  
Backpack\_C502B8 and log into  
IP Address 192.168.43.1  
in a web browser

7. On a PC, Laptop or MacBook, open the wireless network utility.
8. Locate and select the Backpack from the list of wireless devices. The Backpack will then connect to the PC, Laptop, or MacBook. Note that the connection process can take up to 20 seconds

 **HELPFUL!** The Backpack will display in wireless utility like below:  
**Backpack\_<Last Six Digits of Mac Address to the Wireless Module>**.

Refer to the image to the right.

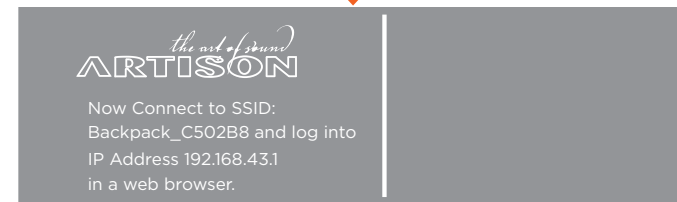
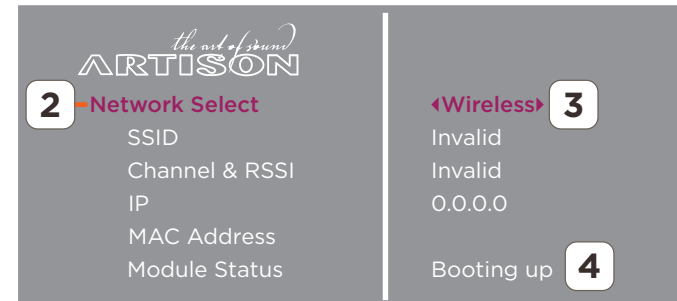



## Connect to Web UI and set Static IP

Connect to the Web UI using the IP Address of the Backpack while in broadcast (Adhoc) mode.

9. Open a Web browser and enter the **192.168.43.1** IP address. This is the IP Address given to the Backpack from the previous section.
10. Scroll down and enable Static IP ON/OFF.
11. Enter the required information in the fields that open.
12. Select the **SAVE** button. The information will now be saved into the Backpack.
13. After about 10 seconds, open a new browser and enter the new static IP Address. The Backpack Web UI will open and the new static IP information will be populated under the Static IP Address section.



**HELPFUL!** During the install process, the LEDs on the front panel will illuminate from left to right indicating that firmware is installing.

192.168.43.1 **9**



**SAVANT  
ARTISON  
BACKPACK**

**DEVICE SETUP**

**10**  Static IP ON/OFF

To configure Static IP, please fill in all of the fields.

**11**

**IP ADDRESS**  
0.0.0.0

**NET MASK**  
0.0.0.0

**GATEWAY**  
0.0.0.0

**PRIMARY DNS**  
0.0.0.0

**SECONDARY DNS**  
0.0.0.0

**12** **SAVE**

Setup your Backpack to join your network of choice. Static IP ON will help to configure with Static IP address. Configure Manually will help to configure with a Hidden Network

## DLNA

DLNA supported players can push music files to the Backpack P5 through their 3rd party applications. (Backpack does not support video or images files). The Backpack supports the following music file formats:

- WMA	- MP3	- LPCM	- FLAC	- HE-AAC
- AAC/AAC+	- APE	- DSD	- AC3	- OGG Vorbis

To change the DLNA name that is broadcast, do the following:

1. Enter the IP address of the Backpack into a web browser. This will open the Backpack Web UI.
2. Locate the DEVICE NAME heading. The name in the field below it is the name that is broadcast over the DLNA network.
3. Highlight and modify the existing name and select **Apply**.
4. In the page that opens, verify the text reads **New Settings were successfully applied**. After a few seconds the page will switch back to the Backpack Web UI page.
5. Verify the DEVICE NAME field presents the new name that will be broadcast.

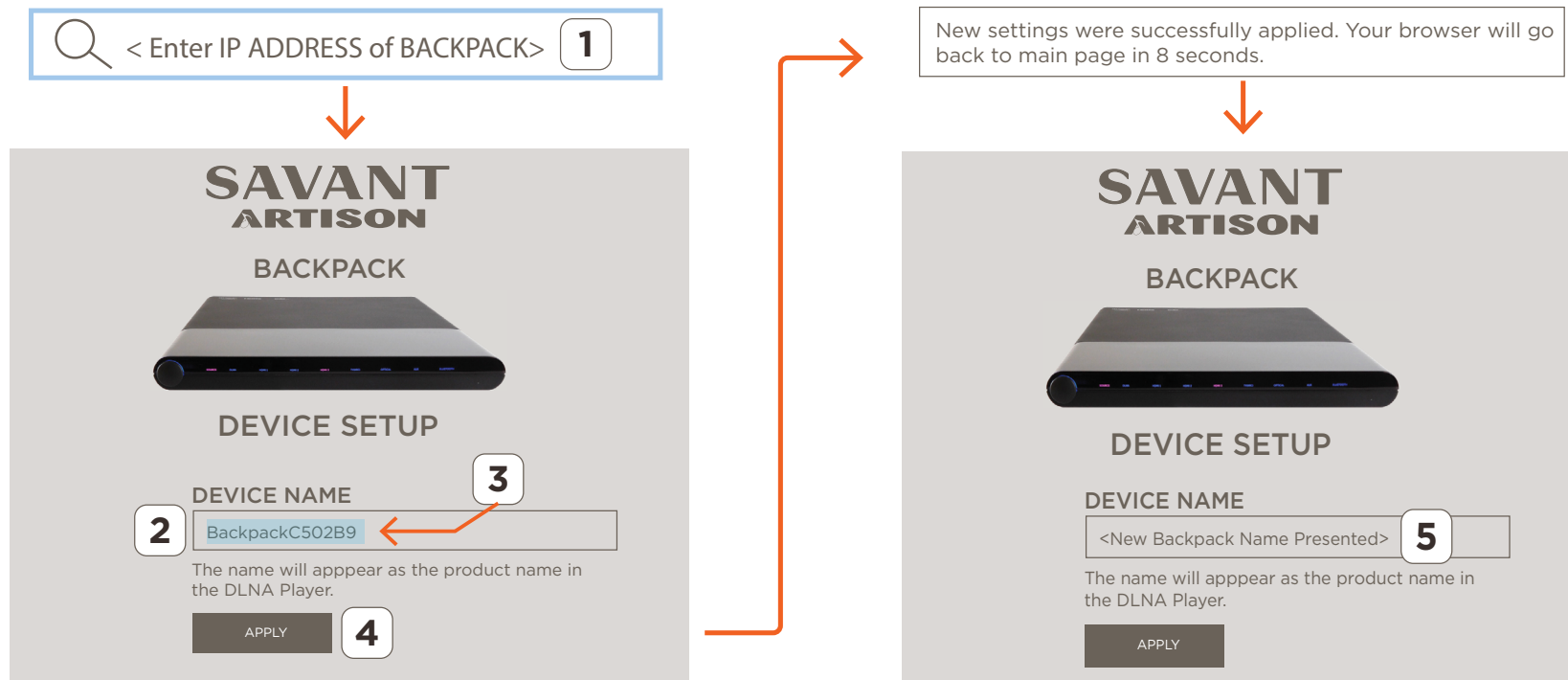

The Backpack broadcasts the DLNA as:

Backpack<last six characters of Bluetooth wireless module Mac Address>.

## On Screen Display Pop-Up Info Banner

Available to the Backpack is an On Screen Display Info Pop-Up banner that will display the following:

- The name/label of the source input selected.
- The incoming audio format of the source input.
- The incoming video format and frame rate of the source input.
- The surround/listening mode set on that input.
- The volume level of the Backpack.

To open the banner, press either the OK button or any of the input source buttons on the remote. Below is an example of what the banner looks like.

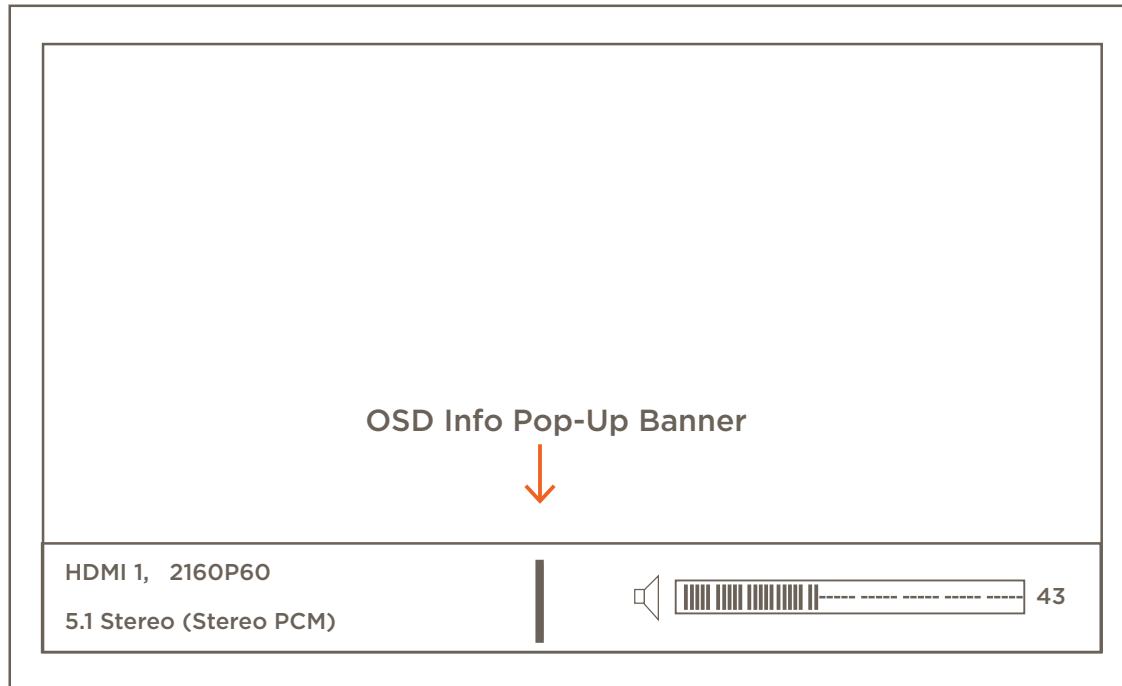

To open the banner, press either the **OK** button, or any of the source input buttons on the remote. An example of what the banner looks like is shown in image.

### ADDITIONAL INFORMATION:

- When the incoming signal is Multichannel PCM, Dolby Digital, or DTS, the surround mode is disabled and will be passed through the Backpack.
- When the incoming audio is 2 channel audio, the surround mode can be modified. If incoming audio is anything else (Dolby Digital, DTS, or Multi-Channel pcm audio), the surround mode can't be modified.

Supported surround modes: 2.1 Stereo, 5.1 Stereo, Dolby PLII Movie, Dolby PLII Music, DTS Neo: 6 Cinema, DTS Neo: 6 Music

- Brackets ( ..... ) indicate the input signal is 2 channel/stereo pcm.

## Appendix B: Network Requirements

Savant requires the use of business class/commercial grade network equipment throughout the network to ensure the reliability of communication between devices. These higher quality components also allow for more accurate troubleshooting when needed.

### Device Network Connections

Connect all Savant devices to the same local area network (LAN) or subnet as the Host. Savant recommends not implementing any type of traffic or packet shaping in your network topology for the Savant devices as this may interfere with performance.

### Managing IP Addresses

To ensure that the IP Address will not change due to a power outage, a static IP Address or DHCP reservation should be configured. Savant recommends using DHCP reservation within the router. By using this method, static IP Addresses for all devices can be managed from a single UI avoiding the need to access devices individually. Setting DHCP reservation varies from router to router. Refer to the documentation for the router to configure DHCP reservation.

### Network Changes

Savant recommends performing one of the following steps to refresh the IP connection after connecting to a new network, changing routers, or if the IP Address range is changed in the current router. This will reset any IP connection and ensure that the Host is communicating with the network correctly.

To refresh the IP Connection, perform one of the following steps:

- **Unplug/Plug Ethernet Connection**
  1. Unplug Ethernet cable.
  2. Wait 15 seconds.
  3. Re-insert Ethernet cable back into Ethernet port.
- **Reset All field**
  1. Using the Backpack remote, scroll to and select **Network Setup** field.
  2. Scroll down and highlight the **Reset All** field.
  3. Select **OK**. Backpack will reboot and network settings will be restored to defaults.



**IMPORTANT!** To ensure the IP Address does not change due to a power outage or similar, a static IP Address or DHCP reservation should be configured. Savant recommends using DHCP reservation within the router. Setting DHCP reservation varies from router to router. Refer to the documentation for the router when configuring DHCP reservation.

# Important Notice

## Disclaimer

Savant Systems, LLC. reserves the right to change product specifications without notice, therefore, the information presented herein shall not be construed as a commitment or warranty.

Savant Systems, LLC. shall not be liable for any technical or editorial errors or omissions contained herein or for incidental or consequential damages resulting from the performance, furnishing, reliance on, or use of this material.

## Patents

Certain equipment and software described in this document is protected by issued and pending U.S. and foreign patents.

All products and services are trademarks or registered trademarks of their respective manufacturer.

## Copyright

This document contains confidential and proprietary information protected by copyright. All rights reserved. Copying or other reproduction of all or parts of this document is prohibited without the permission of Savant Systems.

## Trademarks

© 2019 Savant Systems, LLC. All rights reserved. Savant, Savant App, Truelmage, Savant Host, Now You Can, RacePoint Blueprint, Single App Home, TrueCommand, TrueControl, and the Savant logo are trademarks of Savant Systems, LLC.

AirPlay, Apple, AirPort Express, AirPort Extreme, Apple TV, Apple Remote Desktop, FireWire, iMac, iTunes, iPad, iPad mini, iPad Air, iPhone, MacBook, Mac and OS X are trademarks or trade names of Apple Inc. iOS is a trademark of Cisco®. Android, Google, Google Play, and other Google marks are trademarks of Google, Inc. Wi-Fi is a registered trademark of the Wi-Fi Alliance®. HDMI® is a trademark of HDMI Licensing, LLC. MOTU® is a registered trademark of Mark of the Unicorn, Inc. Luxul is a registered trademark of Luxul Wireless. NETGEAR®, the NETGEAR Logo and ProSAFE are trademarks of NETGEAR, Inc. Extreme™ is a trademark of Extreme Networks, Inc.

All other brand names, product names, and trademarks are the property of their respective owners.

## Technical and Sales Support

Savant Systems, LLC is dedicated to providing prompt and effective support in a timely and efficient manner.

- To contact Savant Support, access the Savant Customer Community and enter a support Case ticket.
- To contact Savant Sales, visit Savant.com and select Contact Us to locate a local sales representative in your area.